

## Addendum for FI027DL

### INFO

	BK	BN	BU	GY	GN	WH	YE	OG	PE	PI	RD
DE	Schwarz	Braun	Blau	Grau	Grün	Weiß	Gelb	Orange	Violett	Rosa	Rot
FR	Noir	Marron	Blue	Gris	Vert	Blanc	Jaune	Orange	Violet	Rose	Rouge
NL	Zwart	Bruin	Blauw	Grijs	Groen	Wit	Geel	Oranje	Paars	Roze	Rood
GB	Black	Brown	Blue	Grey	Green	White	Yellow	Orange	Purple	Pink	Red
ES	Negro	Marrón	Azul	Gris	Verde	Blanco	Amarillo	Naranja	Morado	Rosa	Rojo
IT	Nero	Marrone	Blu	Grigio	Verde	Bianco	Giallo	Arancione	Viola	Rosa	Rosso
SE	Svart	Brun	Blå	Grå	Grön	Vit	Gul	Orange	Lila	Rosa	Röd
CZ	Černá	Hnědá	Modrá	Šedá	Zelená	Bílá	Žlutá	Oranžová	Fialová	Růžová	Červená
DK	Sort	Brun	Blå	Grå	Grøn	Hvid	Gul	Orange	Lilla	Pink	Rød
FI	Musta	Ruskea	Sininen	Harmaa	Vihreä	Valkoinen	Keltainen	Oranssi	Purppura	Vaaleanpunainen	Punainen
GR	Μαύρο	Καφέ	Μπλε	Γκρι	Πράσινο	Λευκό	Κίτρινο	Πορτοκαλί	Μοβ	Ροζ	Κόκκινο
NO	Svart	Brun	Blå	Grå	Grønn	Hvit	Gul	Oransje	Lilla	Rosa	Rød
PL	Czarny	Brązowy	Niebieski	Szary	Zielony	Biały	Żółty	Pomarańczowy	Purpurowy	Różowy	Czerwony

### 1

54			
GN/BK	<del>GN/BK</del>		
58L			
YE/GN	<del>YE/GN</del>		
L			
PI/BK	<del>PI/BK</del>		
Reverse			
WH/RD	<del>WH/RD</del>		
L			
BN/BK	<del>BN/BK</del>		

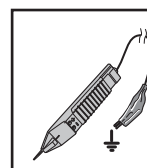
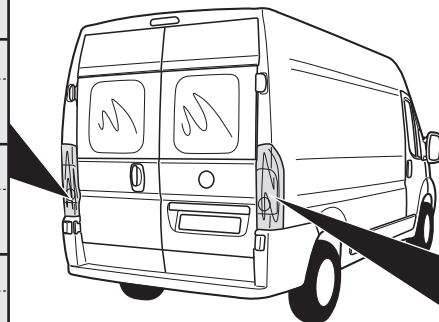

- DE Farben
- FR Couleurs
- NL Kleuren
- GB Colours
- ES Colores
- IT Colori
- SE Färgar
- CZ Barevným
- DK Farverne
- FI Coloria
- GR χρώματα
- NO Farger
- PL Kolorowac

58R			
YE	<del>YE</del>		
R			
PI	<del>PI</del>		
R			
BN	<del>BN</del>		

### 2

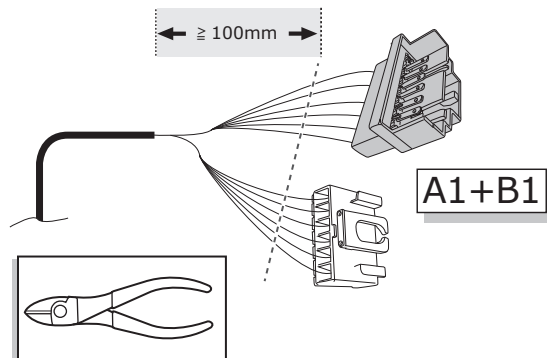
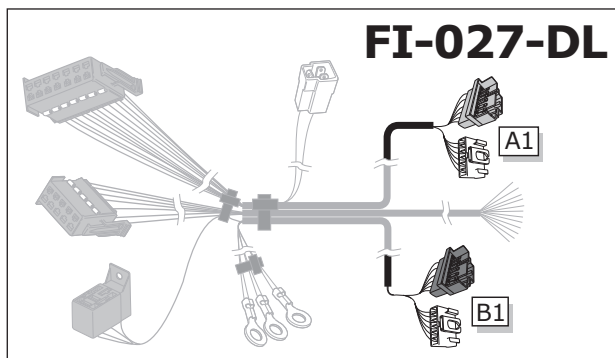

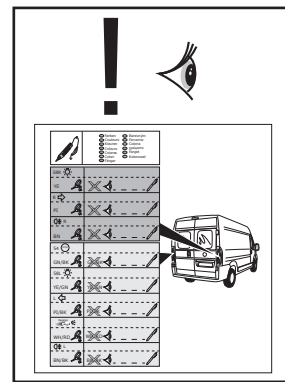
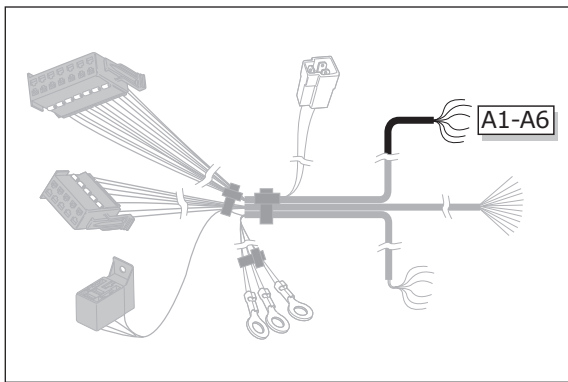
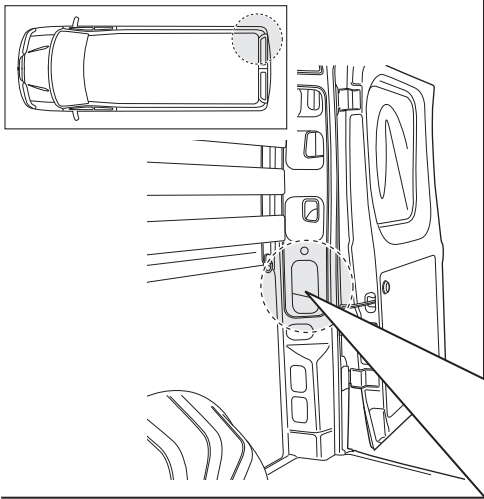

**INFO**

**Pag. 1**

DE Farben	CZ Barevným
FR Couleurs	ES Farverne
NL Kleuren	FI Coloria
GB Colours	GR χρώματα
ES Colores	NO Farget
IT Colori	PL Kolorować
SE Färger	

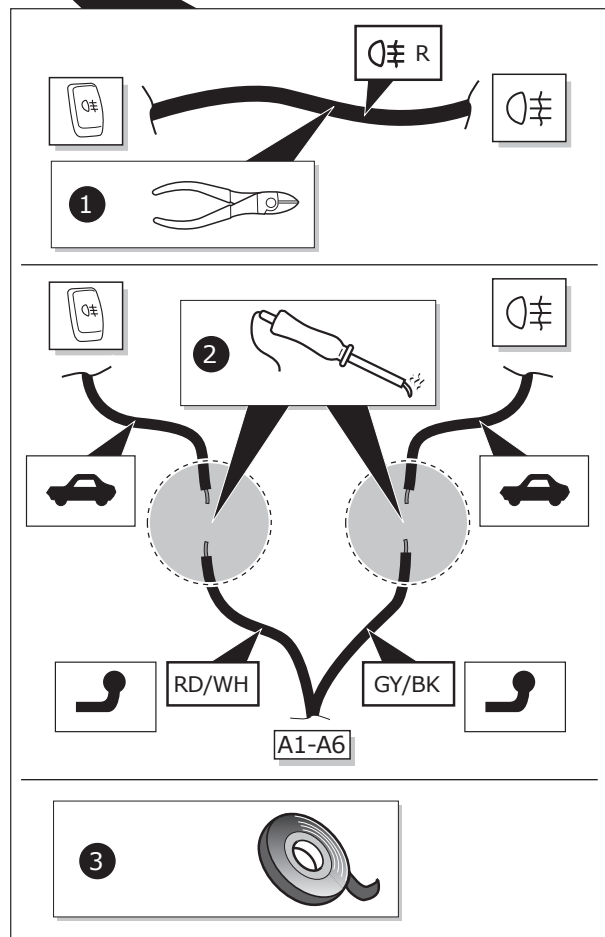
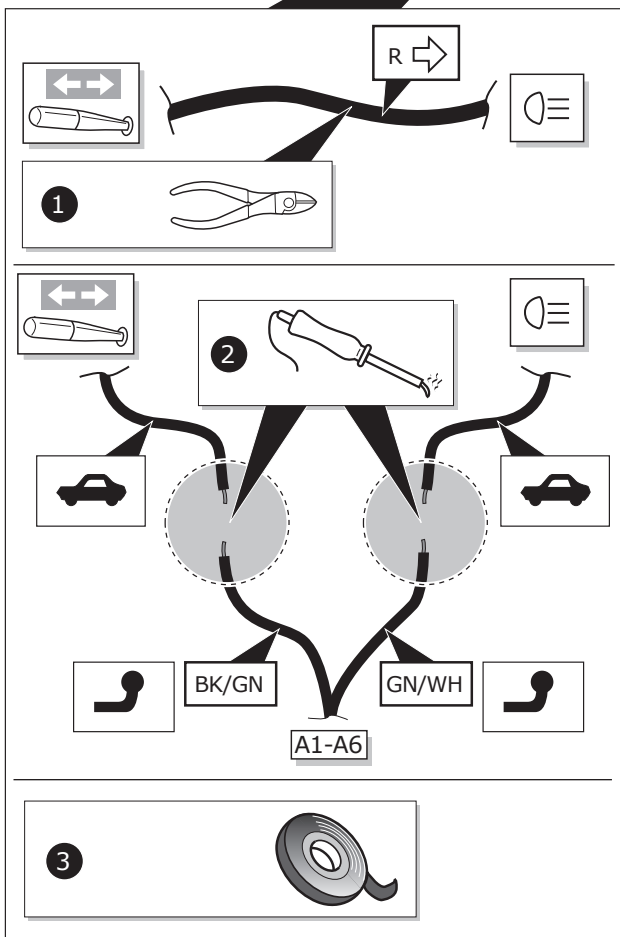
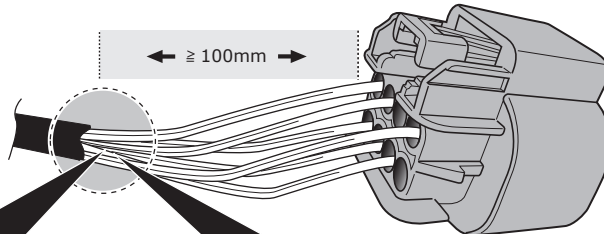

- DE BITTE BEACHTEN: Sorgfältig löten und isolieren!
- FR ATTENTION: Souder et isoler précisément!
- NL LET OP: Zorgvuldig solderen en isoleren!
- GB N.B.: To solder and isolate carefully!
- ES ATENCIÓN: ¡Soldar y aislar cuidadosamente!
- IT ATTENZIONE: Saldare e isolare con cura!
- SE OBS: Löd och isolera noggrant!

- CZ N.B.: Pečlivě pájejte a izolujte!
- DK N.B.: Lod og isoler grundigt!
- FI HUOMIO: Juota ja eristä huolellisesti!
- GR Σ.Σ.: Κολλήστε με κασίτερο και μονώστε προσεκτικά!
- NO VIKTIG: Sveis sammen og isoler nøye!
- PL UWAGA: Starannie przylutować i zaizolować!



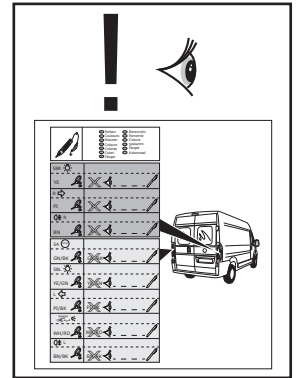
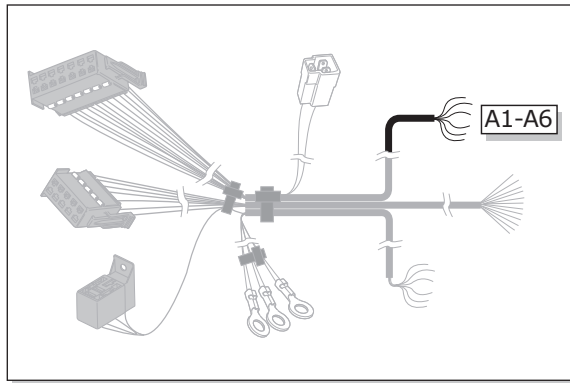
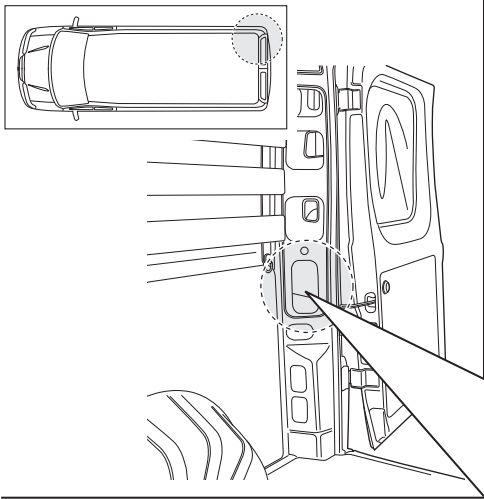

## INFO

Pag. 1

DE	Farben	CS	Barevným
FR	Couleurs	DK	Farverne
NL	Kleuren	FI	Coloria
GB	Colours	GR	χρώματα
ES	Colores	NO	Farger
IT	Colori	PL	Kolorować
SE	Färger		

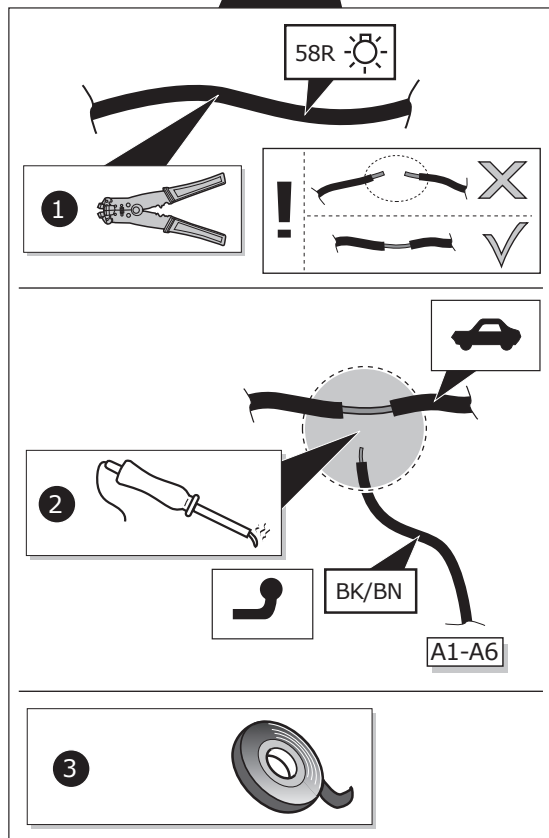
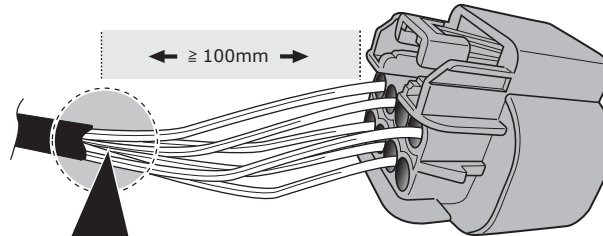

DE BITTE BEACHTEN: Sorgfältig löten und isolieren!

FR ATTENTION: Souder et isoler précisément!

NL LET OP: Zorgvuldig solderen en isoleren!

GB N.B.: To solder and isolate carefully!

ES ATENCIÓN: ¡Soldar y aislar cuidadosamente!

IT ATTENZIONE: Saldare e isolare con cura!

SE OBS: Löd och isolera noggrant!

CZ N.B.: Pečlivě pájejte a izolujte!

DK N.B.: Lod og isoler grundigt!

FI HUOMIO: Juota ja eristä huolellisesti!

GR Σ.Σ.: Κολλήστε με κασσίτερο και μονώστε προσεκτικά!

NO VIKTIG: Sveis sammen og isoler nøye!

PL UWAGA: Starannie przylutować i zaizolować!



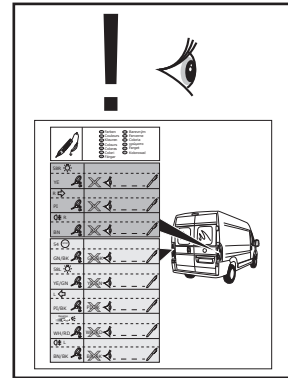
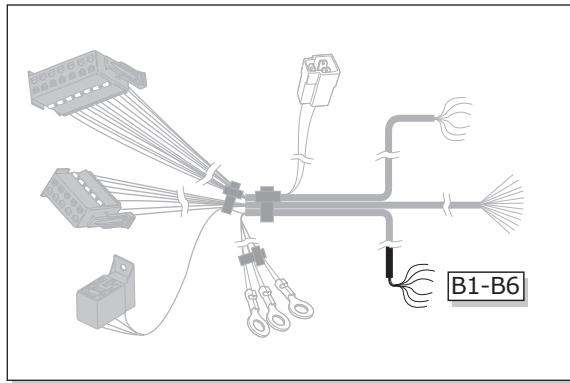
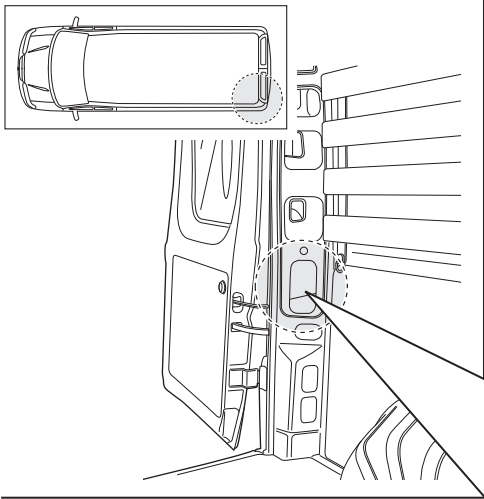

**INFO**

**Pag. 1**

DE Farben	CZ Barevným
FR Couleurs	ES Farverne
NL Kleuren	FI Coloria
GB Colours	GR χρώματα
ES Colores	NO Farget
IT Colori	PL Kolorować
SE Färger	

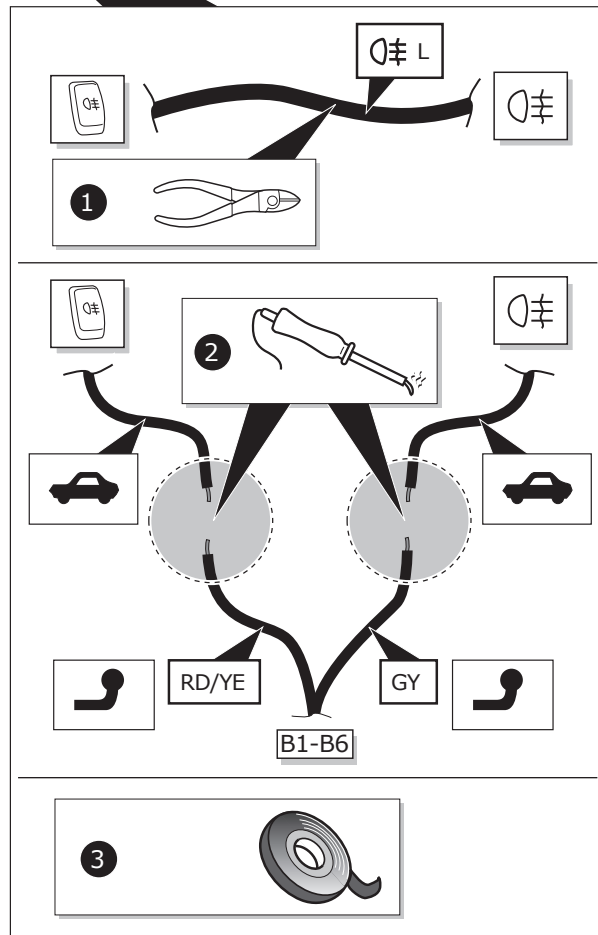
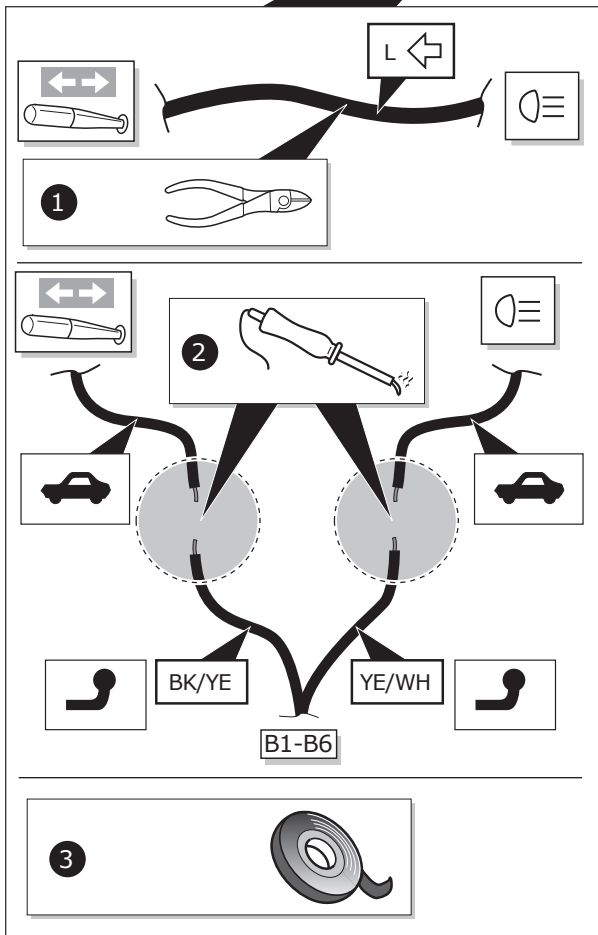
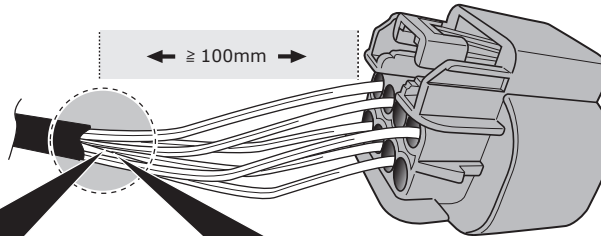

- DE BITTE BEACHTEN: Sorgfältig löten und isolieren!
- FR ATTENTION: Souder et isoler précisément!
- NL LET OP: Zorgvuldig solderen en isoleren!
- GB N.B.: To solder and isolate carefully!
- ES ATENCIÓN: ¡Soldar y aislar cuidadosamente!
- IT ATTENZIONE: Saldare e isolare con cura!
- SE OBS: Löd och isolera noggrant!

- CZ N.B.: Pečlivě pájejte a izolujte!
- DK N.B.: Lod og isoler grundigt!
- FI HUOMIO: Juota ja eristä huolellisesti!
- GR Σ.Σ.: Κολλήστε με κασίτερο και μονώστε προσεκτικά!
- NO VIKTIG: Sveis sammen og isoler nøye!
- PL UWAGA: Starannie przylutować i zaizolować!



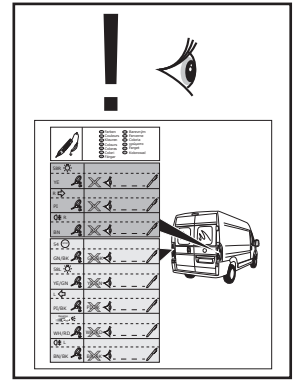
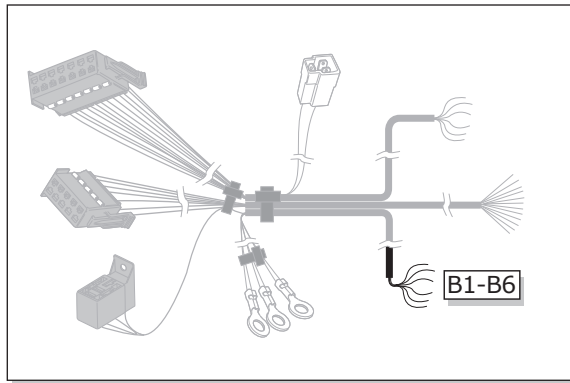
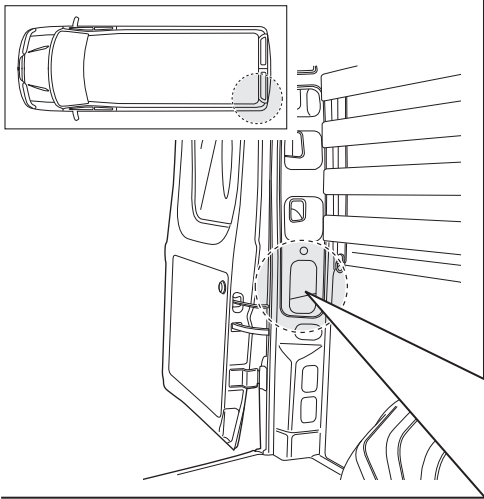

## INFO

Pag. 1

DE	Farben	CZ	Barevným
FR	Couleurs	DK	Farverne
NL	Kleuren	FI	Coloria
GB	Colours	GR	χρώματα
ES	Colores	NO	Farger
IT	Colori	PL	Kolorowac
SE	Färger		

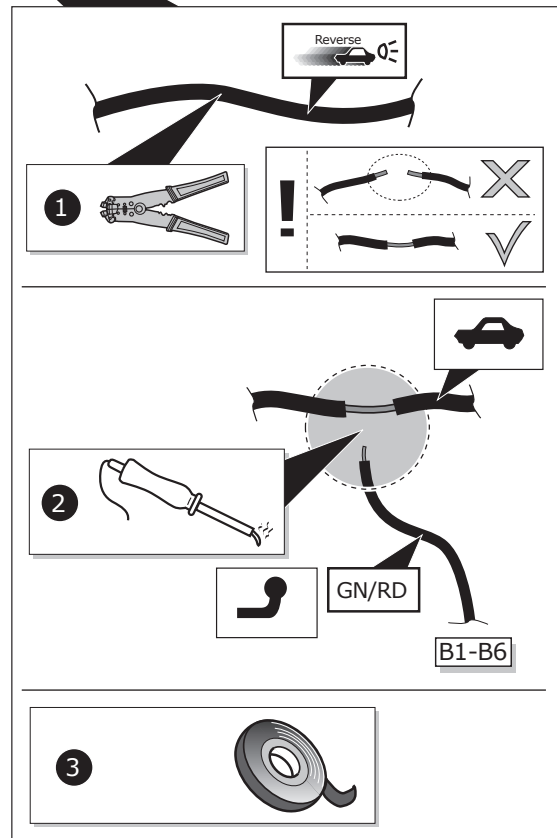
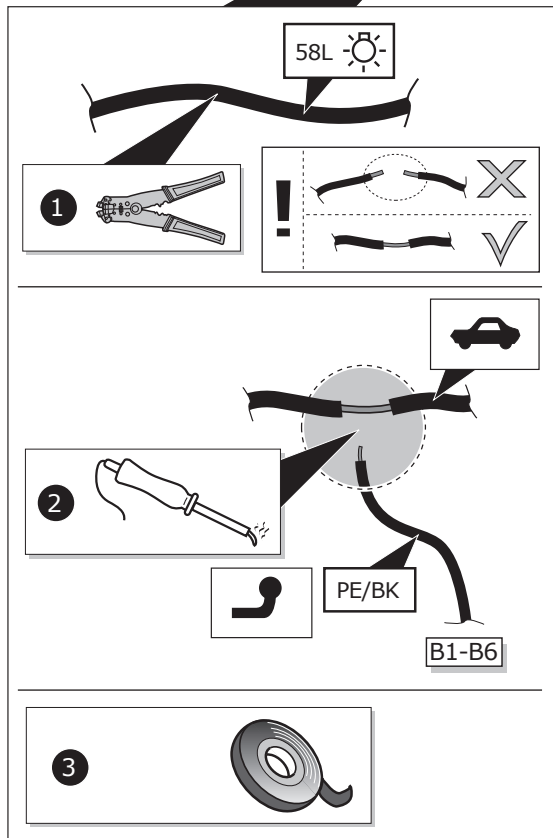
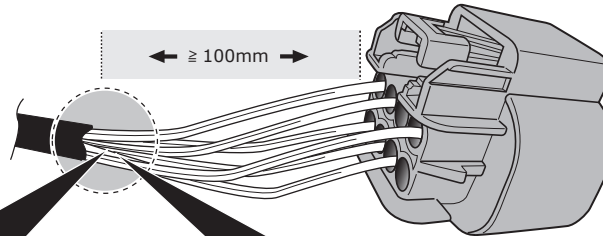

DE BITTE BEACHTEN: Sorgfältig löten und isolieren!  
 FR ATTENTION: Souder et isoler précisément!  
 NL LET OP: Zorgvuldig solderen en isoleren!  
 GB N.B.: To solder and isolate carefully!  
 ES ATENCIÓN: ¡Soldar y aislar cuidadosamente!  
 IT ATTENZIONE: Saldare e isolare con cura!  
 SE OBS: Löd och isolera noggrant!

CZ N.B.: Pečlivě pájejte a izolujte!  
 DK N.B.: Lod og isoler grundigt!  
 FI HUOMIO: Juota ja eristä huolellisesti!  
 GR Σ.Σ.: Κολλήστε με κασίτερο και μονώστε προσεκτικά!  
 NO VIKTIG: Sveis sammen og isoler nøye!  
 PL UWAGA: Starannie przylutować i zaizolować!



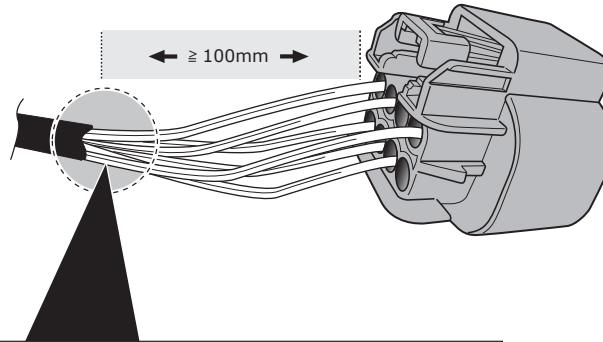
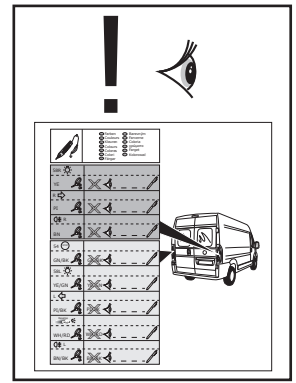
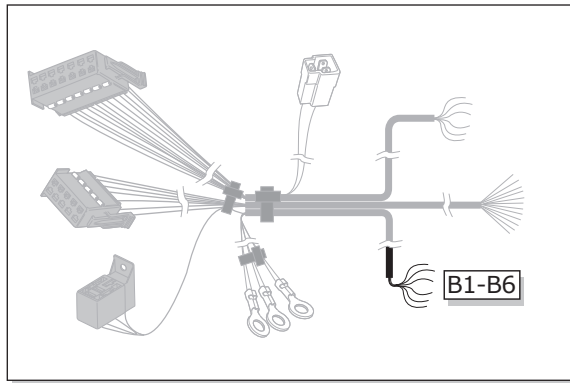
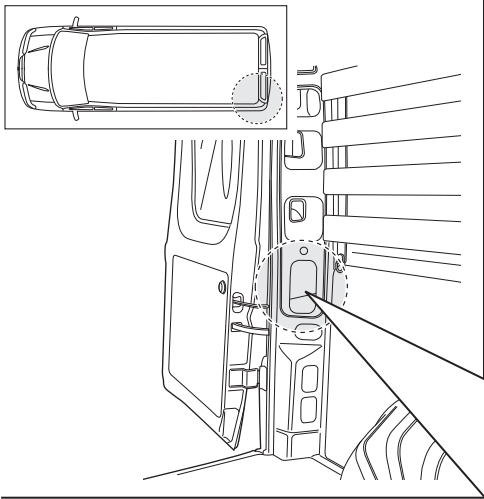

## INFO

Pag. 1

DE	Farben	RU	Базовным
FR	Couleurs	SK	Farverne
NL	Kleuren	ES	Coloria
GB	Colours	EL	χρώματα
ES	Colores	TR	Renkler
IT	Colori	PL	Kolorować
SE	Färger		

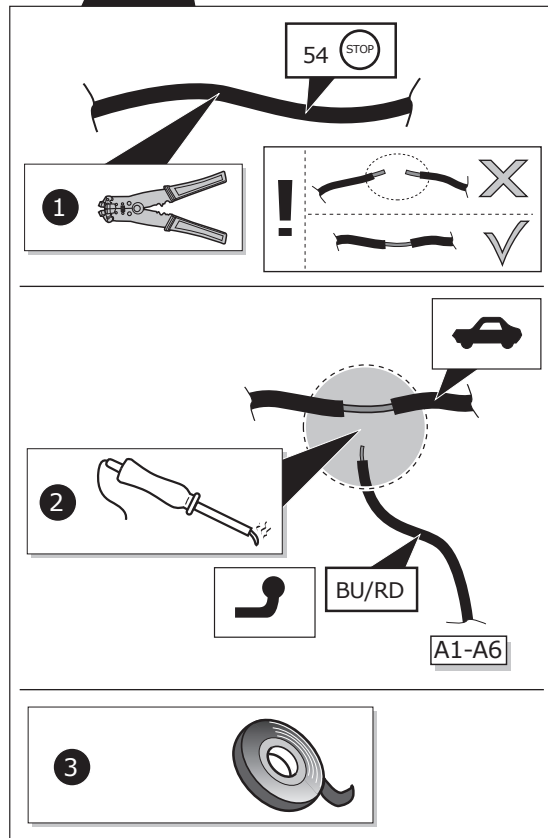

DE BITTE BEACHTEN: Sorgfältig löten und isolieren!

FR ATTENTION: Souder et isoler précisément!

NL LET OP: Zorgvuldig solderen en isoleren!

GB N.B.: To solder and isolate carefully!

ES ATENCIÓN: ¡Soldar y aislar cuidadosamente!

IT ATTENZIONE: Saldare e isolare con cura!

SE OBS: Löd och isolera noggrant!

CZ N.B.: Pečlivě pájejte a izolujte!

DK N.B.: Lod og isoler grundigt!

FI HUOMIO: Juota ja eristä huolellisesti!

GR Σ.Σ.: Κολλήστε με κασσίτερο και μονώστε προσεκτικά!

NO VIKTIG: Sveis sammen og isoler nøye!

PL UWAGA: Starannie przylutować i zaizolować!



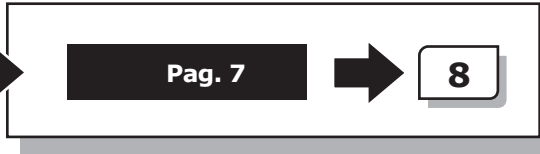
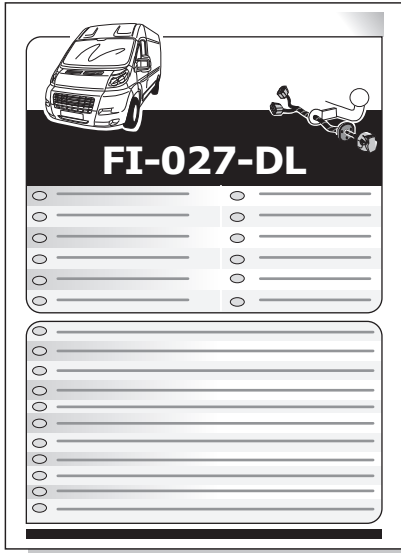

The logo consists of a circular emblem with a telephone handset in the center. The words "ECS HELP LINE" are written in a semi-circle above the handset, and "FREE CALL" is written in a semi-circle below it. To the right of the emblem is a line drawing of a woman with her hair in a ponytail, holding a mobile phone to her ear and smiling.

**00800**  
**CALL2ECS**  
**22 55 23 27**  
09.00 - 18.00  
Monday - Friday  
[www.ecs-electronics.nl](http://www.ecs-electronics.nl)